

PL-301 IAD Voice Gateway User's Manual

<Version: V1.0 (A)>

Copyrights 2005-2006 All Rights Reserved

1. Revision information

Revision History					
Versi	Note	Author	Reviewed by	Approved by	Effective date

2. Terminology

Terminology	
Name	Note

Contents

1 Overview	1
2 Packing.....	1
3 Safety Instructions	1
4 Introduction to IAD	1
5 Performance Indices	3
6 Networking Mode.....	4
6.1 Typical Applications.....	4
7 Appearance Description.....	6
8 Configuration Description.....	6
8.1 LAN Configuration Environment	7
8.2 WAN Configuration Environment.....	8
9 Configuration in WEB Mode	11
9.1 WAN Configuration	11
9.2 LAN Configuration	13
9.3 SIP Configuration.....	16
9.4 H323 Protocol	19
9.5 CODECS Setting.....	21
9.6 System Setting.....	22
9.7 Download Setting.....	24
9.8 Reset Setting	25
10 Troubleshooting.....	25

1 Overview

The popularization of the Internet drives the rapid development of a wide variety of IP-based applications. The IP telephone technology has become the major means for operators to develop voice services now. Especially, IP technology becomes the core of the next generation network (NGN), so the IP-based voice technology will keep soaring speeding the future and become the No. 1 choice of new operators in exploring services.

Upon the market requirement, Linksz Corp. has launched the IAD gateway integrated access device.

As an Integrated Access Device, the upstream port of the IAD can be directly connected to the IP network and its downstream port can be connected to multiple ordinary telephone sets, to provide basic accesses for POTS users. This user port gateway can support two telephone lines and connect multiple telephone sets. At the same time, this device is capable of Internet gateway and can access data stream, such as Email or Internet information. It is also applicable for small-size enterprises and IP telephone bars.

2 Packing

The IAD is packed with color chassis. Upon receiving the product, please confirm whether the fittings are complete. The packing box contains a set of IAD, 1 piece of RJ45 network cable, 1 pieces of telephone cables, one IAD power adapter and user's manual.

3 Safety Instructions

To ensure your safety and safe use of this product, please pay attention to the following items:

- n** Follow the instructions in the user's manual.
- n** Keep the device far away from chemicals and regent.
- n** Store/use the equipment in dry and well-ventilated environment.
- n** Never open the chassis lest the device is short-circuited or damaged.

4 Introduction to IAD

The IAD works with the most popular LINUX embedded operation system and has special CPU and DSP compression algorithms, featuring universal functions and applicable to a wide variety of needs.

Basic features:

- n** One 10/100 BASE-T WAN port, used to connect broadband data network
- n** One 10/100 BASE-T LAN port, bridged to the WAN port.
- n** 1 analog loops starts the FXS interface (RJ-11 Phone), 1 Life Line (RJ-11 PSTN)
- n** Supporting DHCP Client or static IP address allocation plan
- n** Supporting 802.1Q VLAN and VLAN Tag
- n** Mute compression and comfort tone generation technology ensure clear conversation quality.
- n** Self-adaptive jitter cache ensures smooth voice function
- n** Lost-packet compensation guarantee mechanism provides a better voice quality.
- n** Built-in Internet gateway function
- n** Supporting NAT (Network Address Translation) and NAPT
- n** Supporting DHCP Server, used for the dynamic address allocation plan of LAN devices
- n** Built-in PPPoE client, used for broadband access user authentication
- n** Easily-configured Console port
- n** Supporting remote configuration of Web mode and remote software downloading/upgrading

5 Performance Indices

Description of Product Model	
IAD 1FXS+1Life line	IP voice gateway, SIP,H323 protocol
Physical Specifications	
Size	mm (L) × mm (W) × mm (H)
Power supply	AC/DC power adapter, 12V DC DC input: 12V DC/2A
Power consumption	< 15W
Weight	About 0.25 kg
Reliability	System availability > 99.999%, MTBF > 100,000 hours, MTTR < 5 min
Ambient requirements	
Working temperature	0°C ~ 50°C
Storage temperature	-10°C ~ 50°C
Relative humidity	5% ~ 95%, non-condensing
Technical Specifications for the interface attribute gateway	
Supporting MGCP call control protocol	
Mute processing/four wave processing	
RTP/RTCP voice channel	
Voice compression algorithm G.729, G.723 and G.726	
Analog voice port (FXS), 1RJ11 phone +1life line	
Signal format: DTMF	
Echo suppression: G.165/G.168	
DTMF signal detection/generation	
Compatible to the Internet protocols, such as TCP/IP, UDP, ARP, TFTP and ICMP	
Supporting SNMP Version II	
Compatible to IEEE 802.3 10BASE-TX Ethernet	
Compatible to IEEE 802.3u 100BASE-TX fast Ethernet	

6 Networking Mode

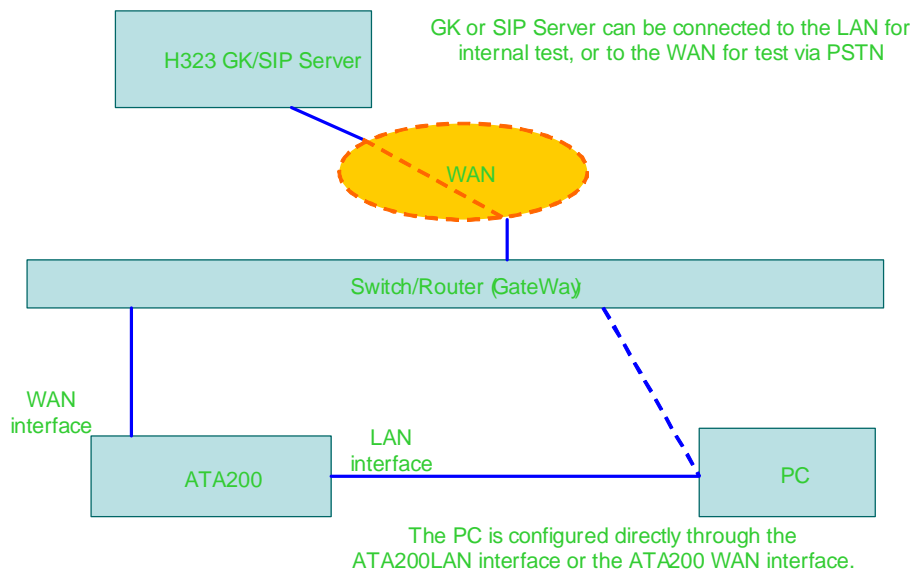

6.1 Typical Applications

The IAD user gateway integrates the Internet gateway and VoIP gateway into a box. Small-size enterprises can use the 10/100Mbps LAN interface to connect local PC with uplink connected to DSL Modem or Cable Modem. They can also use category-5 cables to connect the ISP switch (as shown in Fig. 1). FXS can be connected to two ordinary analog telephone sets to provide conversation based on IP network.

The IAD user gateway also is the ideal access equipment for small and medium scale of telephone bars (as shown in Fig.2). The FXS port can be connected to two ordinary telephone sets. The uplink can be connected to the ITSP (Internet Telephony Service Provider) network through an Ethernet interface connected to the small switch or router.

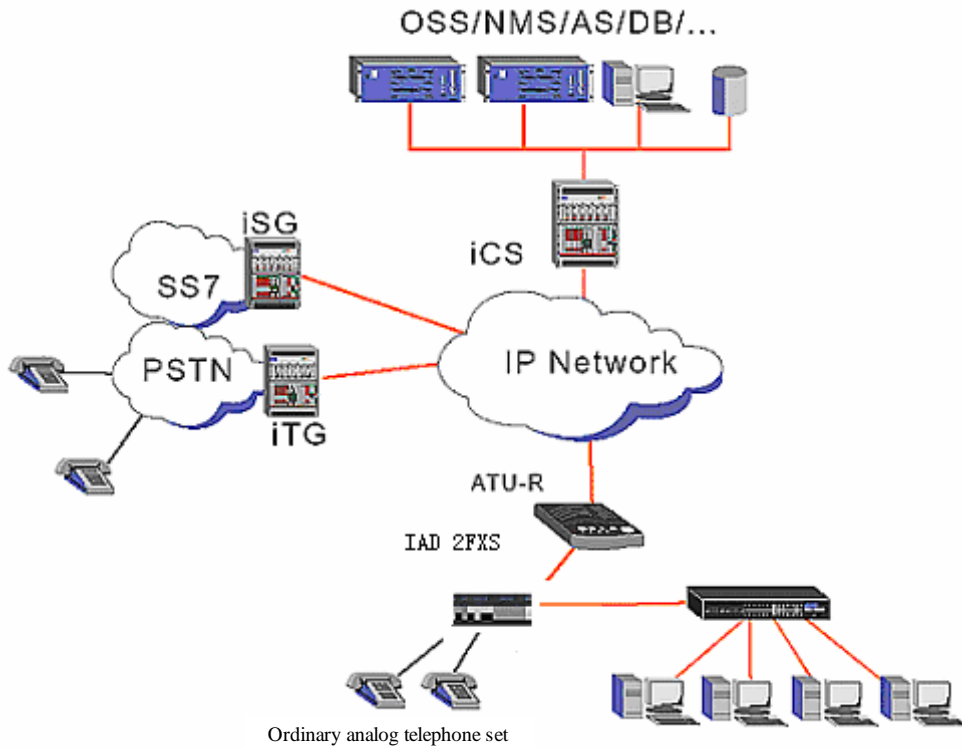

Internet + VOIP System Architecture for Small-size Enterprise/Branch (Copper Cable DSL)

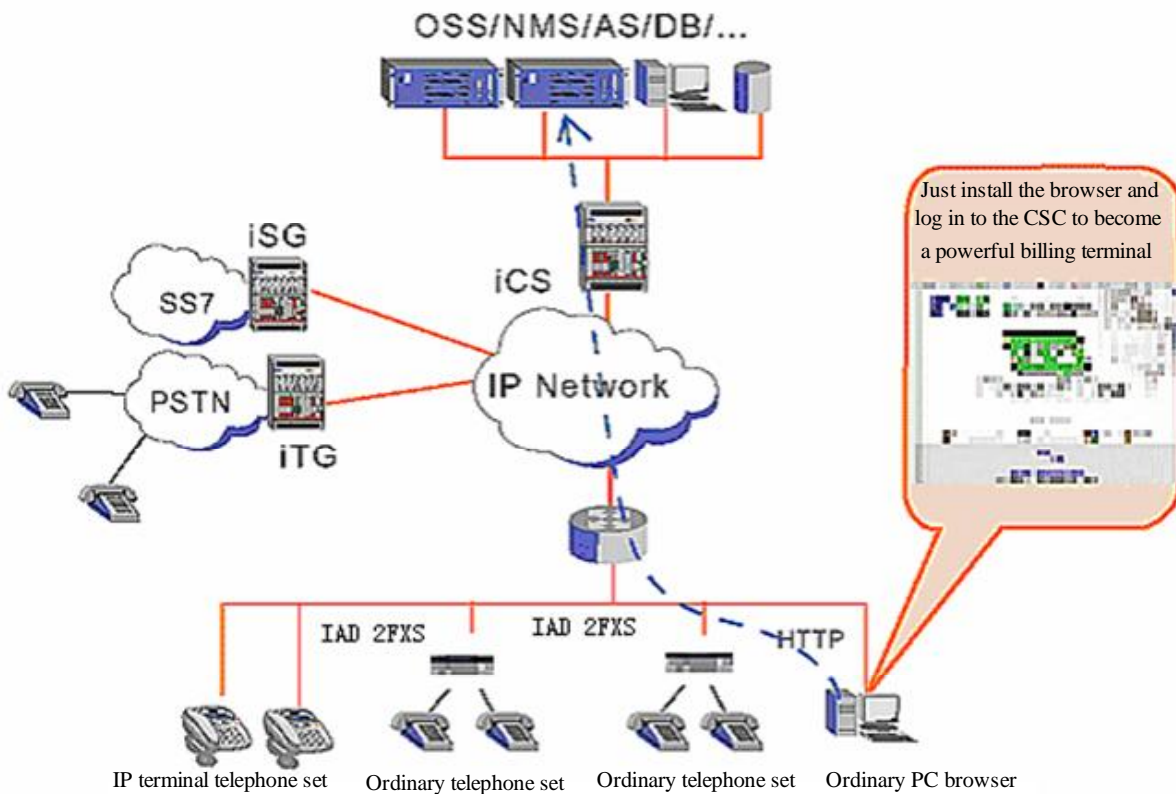

Operator IP Telephone Bar System Architecture (Category-5 Cable)

7 Appearance Description



(old style)

(new style)



8 Configuration Description

The IAD provides two ways to modify WEB parameters: through LAN interface and WAN interface. Below describes how to enter the WEB interface configuration parameter (refer to Chapter 9 *WEB*

configuration interface description) through LAN interface (refer to Section 8.1) or WAN interface (refer to 8.2).

8.1 LAN Configuration Environment

- n Configure the “TCP/IP Protocol” of PC according to Fig. 1 with the default IP addresses of PC and IAD LAN in the same network segment.
- n Configure the device according to Fig. 2.
- n Use straight-through cables in the figure.
- n Configure IE according to Fig. 3.
- n After configuration, input the IAD default IP address in IE address bar. Each IAD will be allocated with an initial Lan IP address before delivery, assumed to be 192.168.0.1.

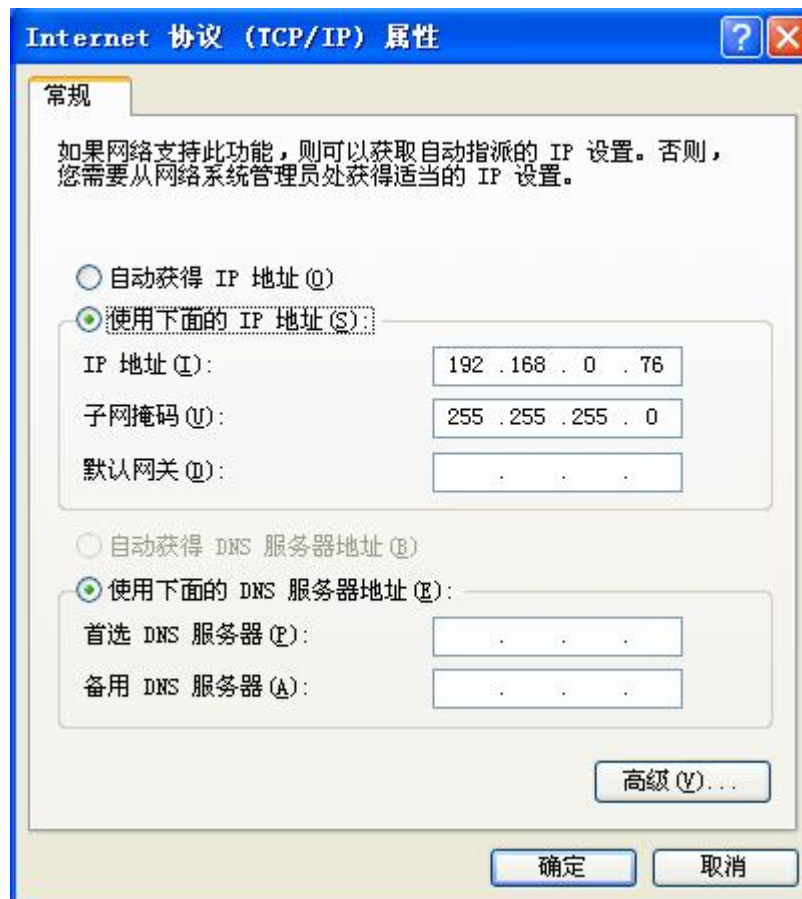

Fig. 1

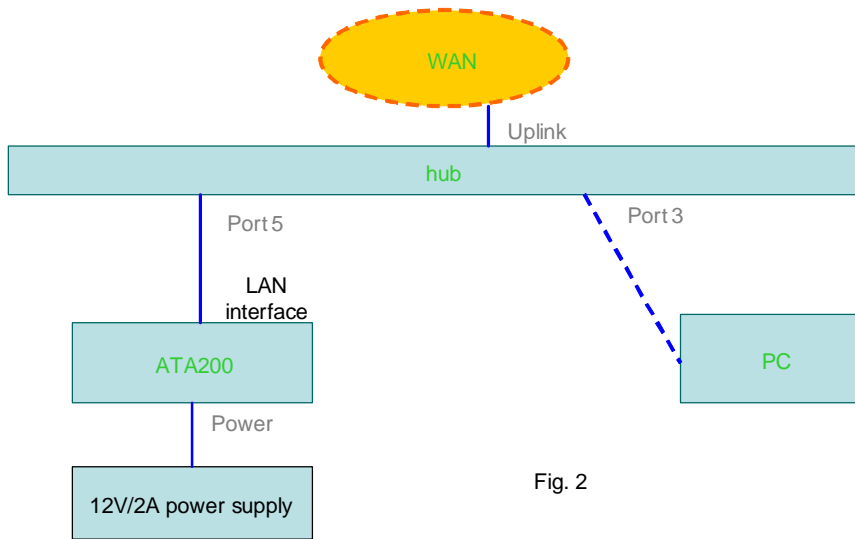

Fig. 2

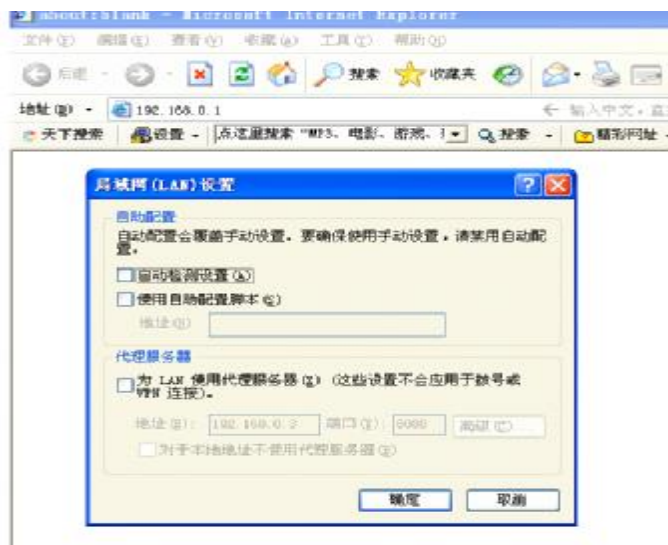

Fig. 3

8.2 WAN Configuration Environment

- n Configure the “TCP/IP Protocol” of PC according to Fig. 4 with the PC and WAN interface in the same network segment.
- n Configure the device according to Fig. 5.
- n Use straight-through cables in the figure.

- n Configure IE according to Fig. 6.
- n After configuration, input the IAD default IP address in IE address bar. Each IAD will be allocated with an initial Wan IP address before delivery, assumed to be 192.168.1.200.

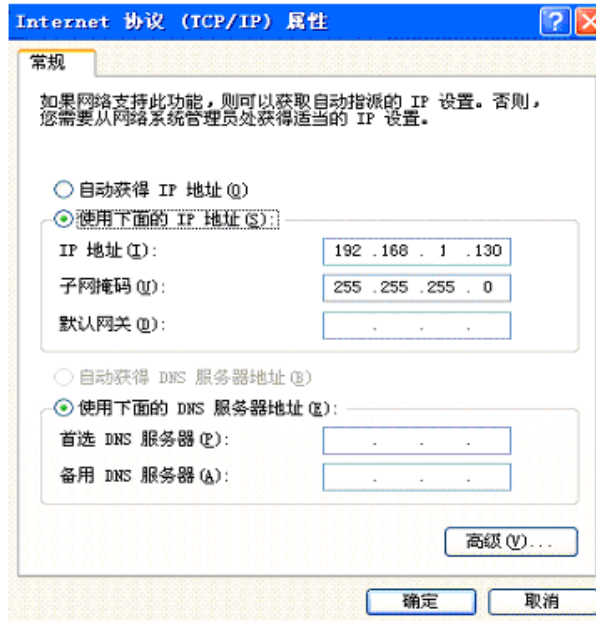

Fig.4

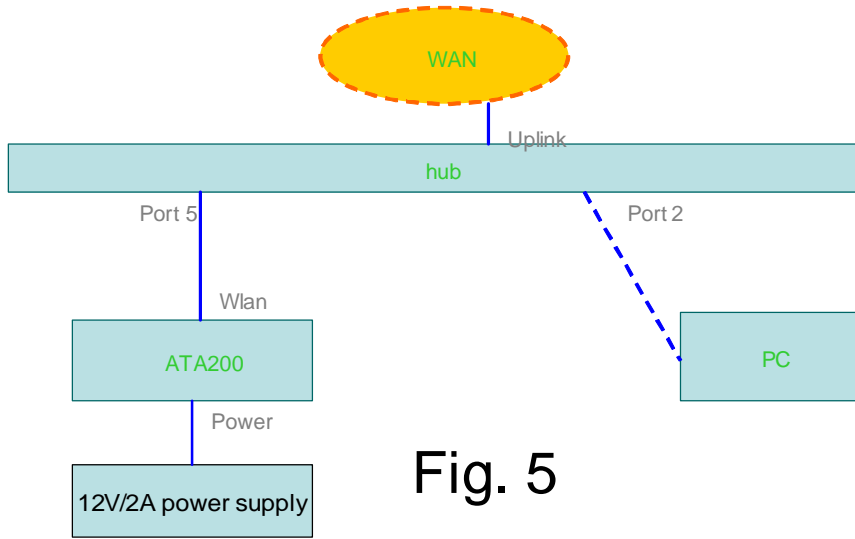

Fig. 5

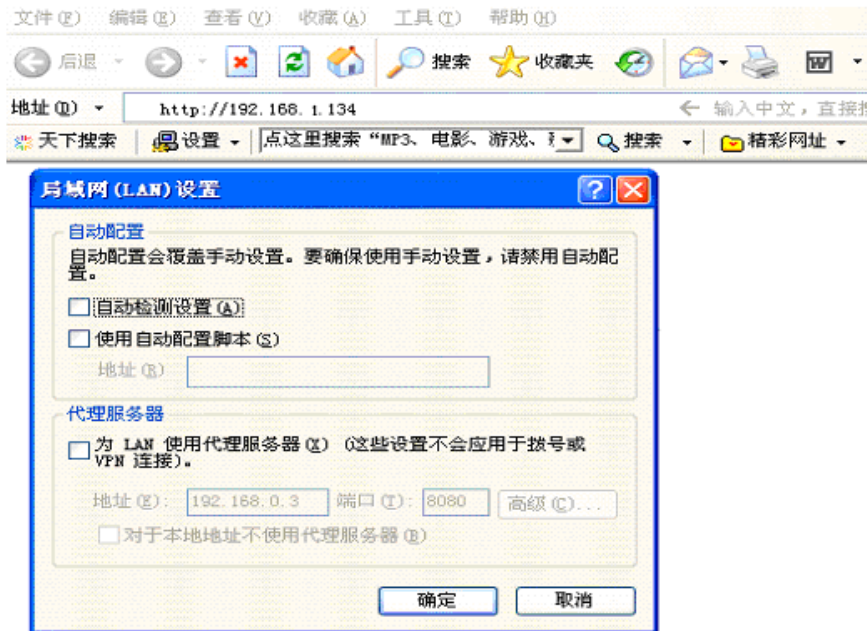
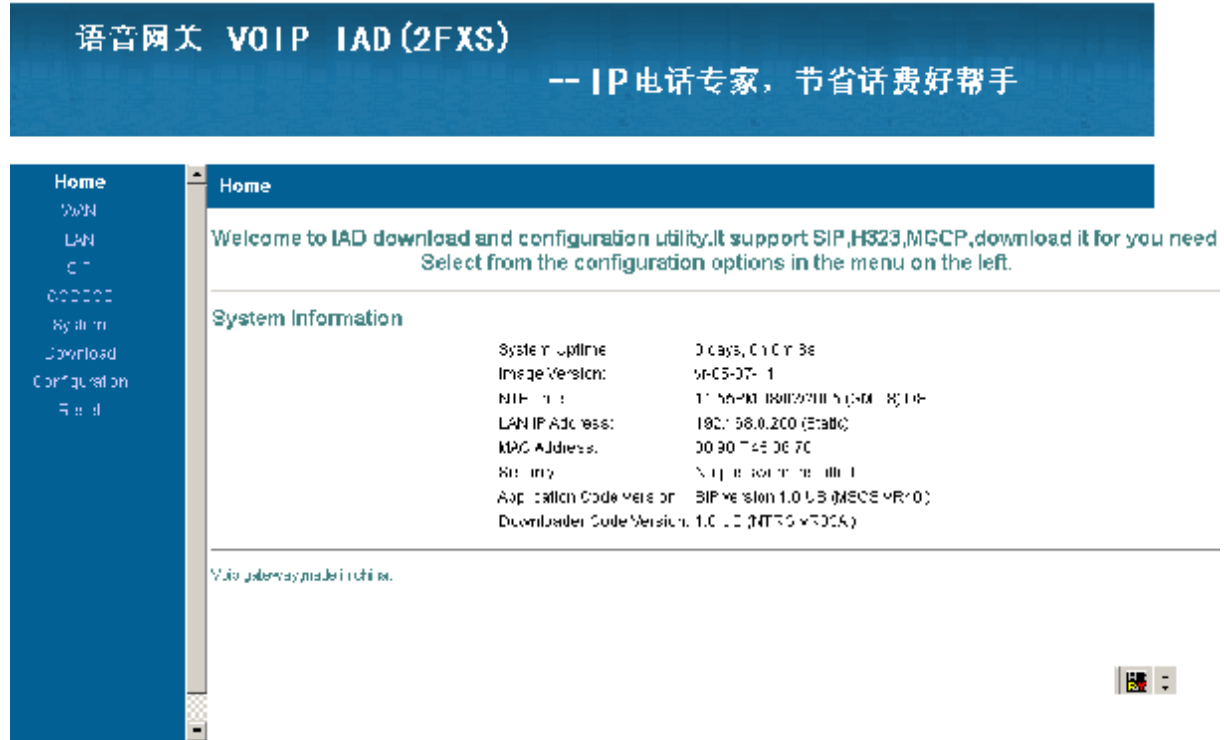

Fig. 6

9 Configuration in WEB Mode

9.1 WAN Configuration



语音网关 VOIP IAD (2FXS)

-- IP电话专家，节省话费好帮手

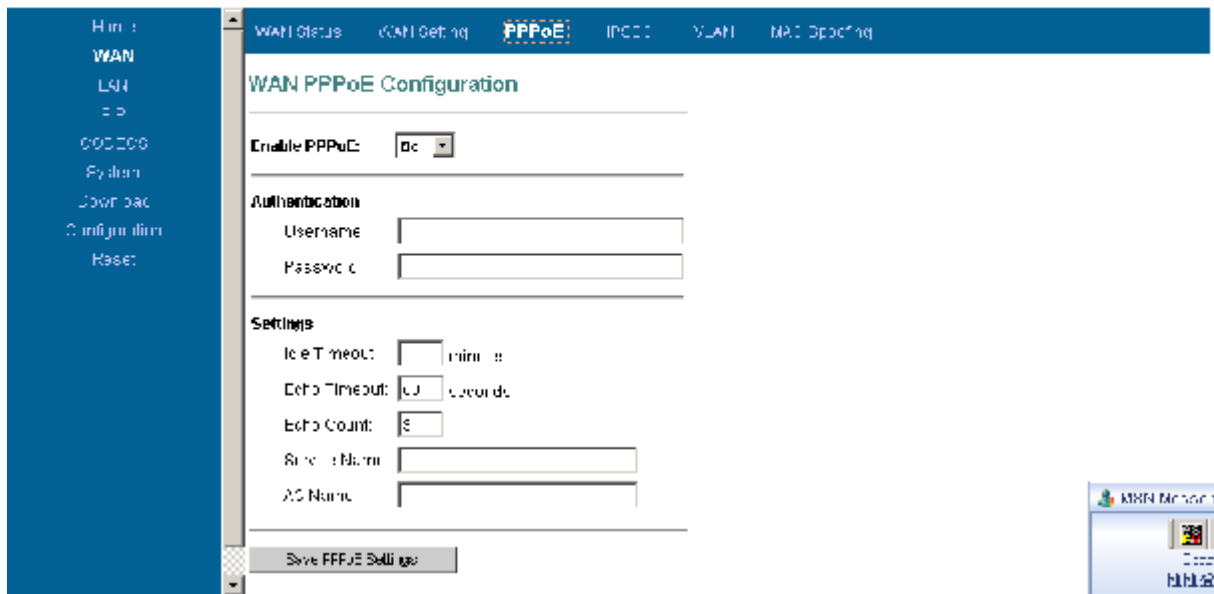

语音网关 VOIP IAD (2FXS)

-- IP电话专家，节省话费好帮手

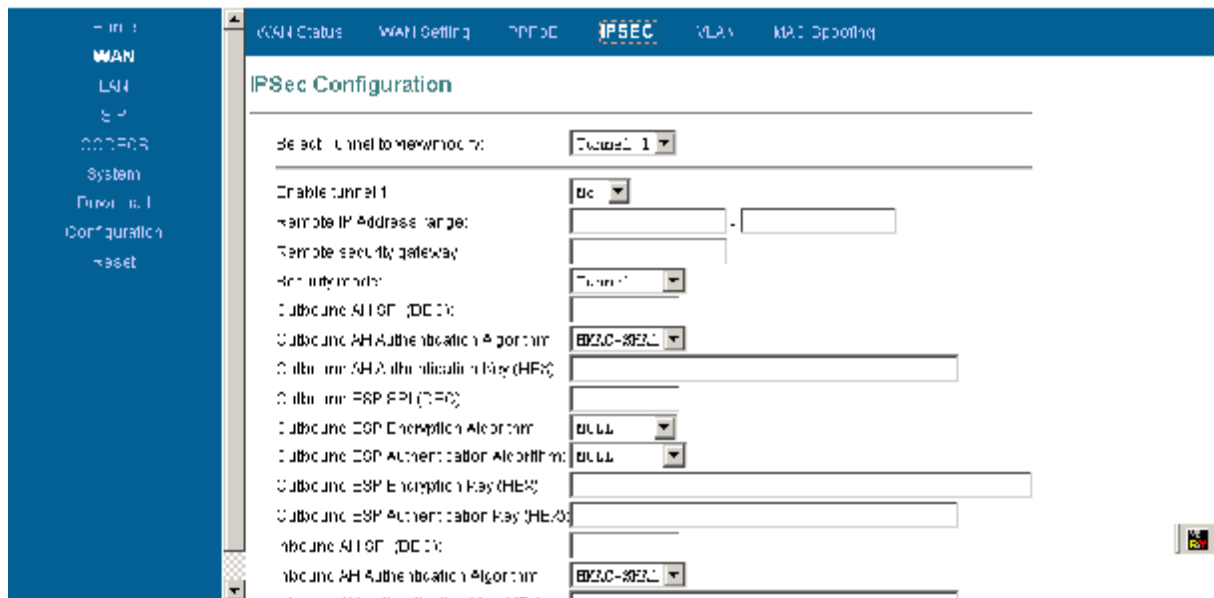



For the setting of MAC Spoofing, if two IADs are configured with the same MAC address, they cannot establish conversation.

9.2 LAN Configuration

If the Lan is an upstream interface, it can be connected to the computer with straight-through cable.

语音网关 VOIP IAD (2FXS) -- IP电话专家，节省话费好帮手

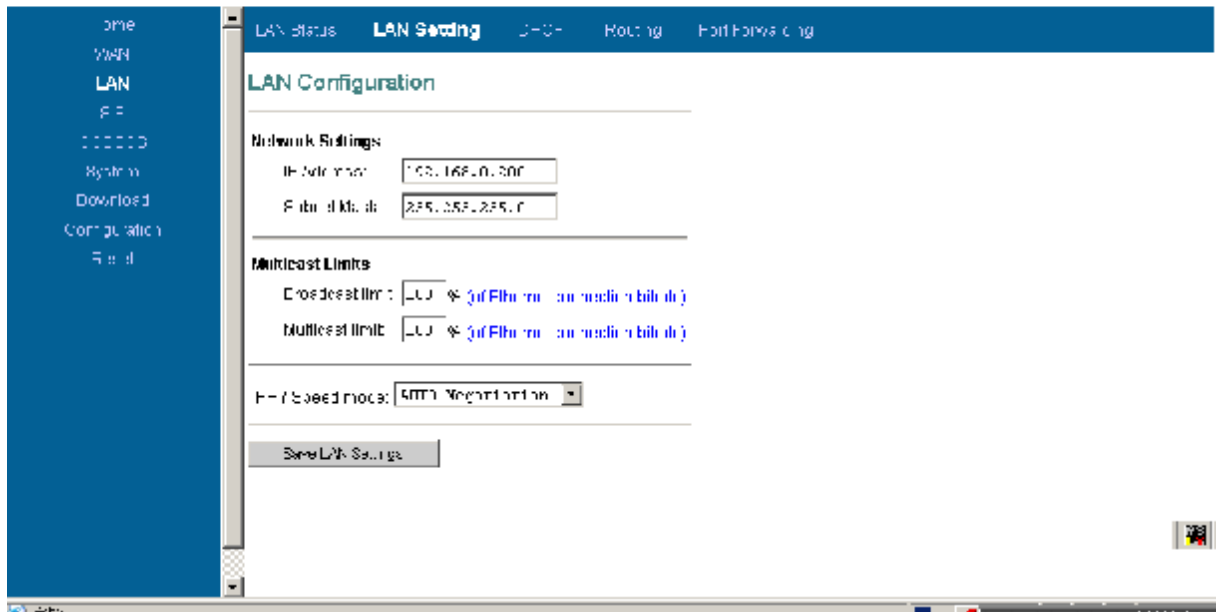

语音网关 VOIP IAD (2FXS) -- IP电话专家，节省话费好帮手

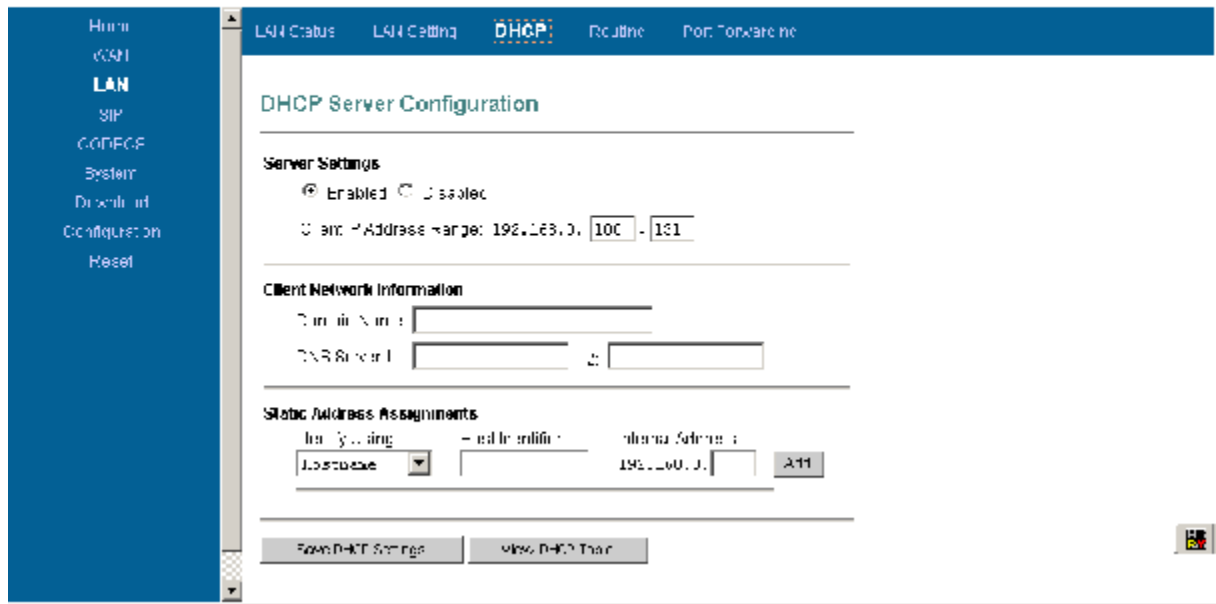

语音网关 VOIP IAD (2FXS) — IP电话专家，节省话费好帮手

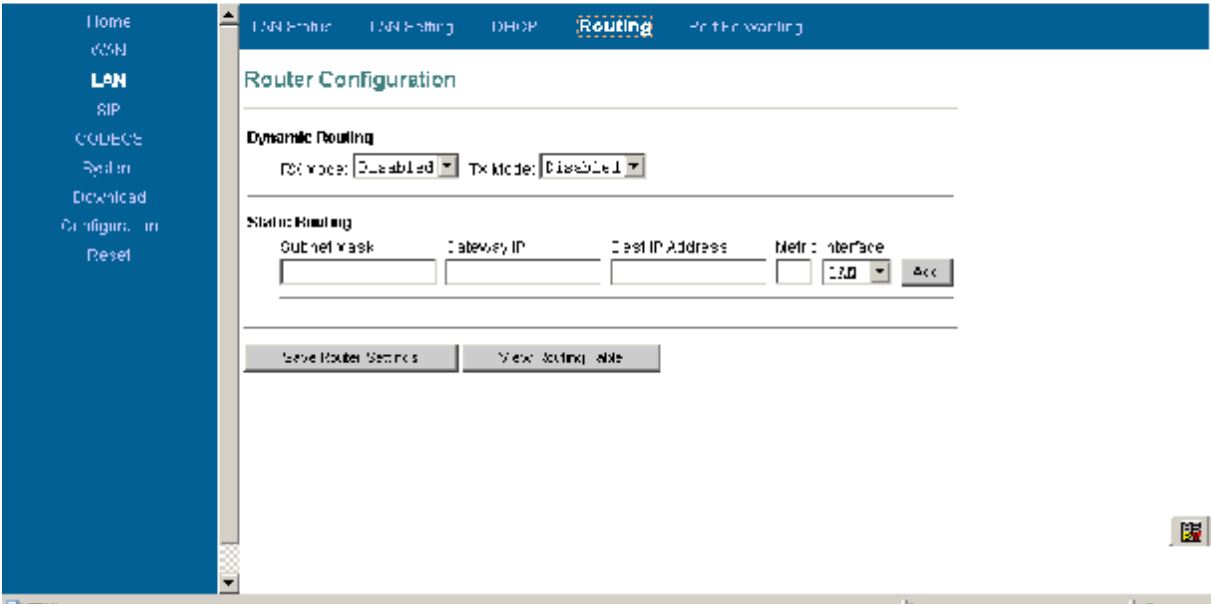

语音网关 VOIP IAD (2FXS) — IP电话专家，节省话费好帮手



9.3 SIP Configuration

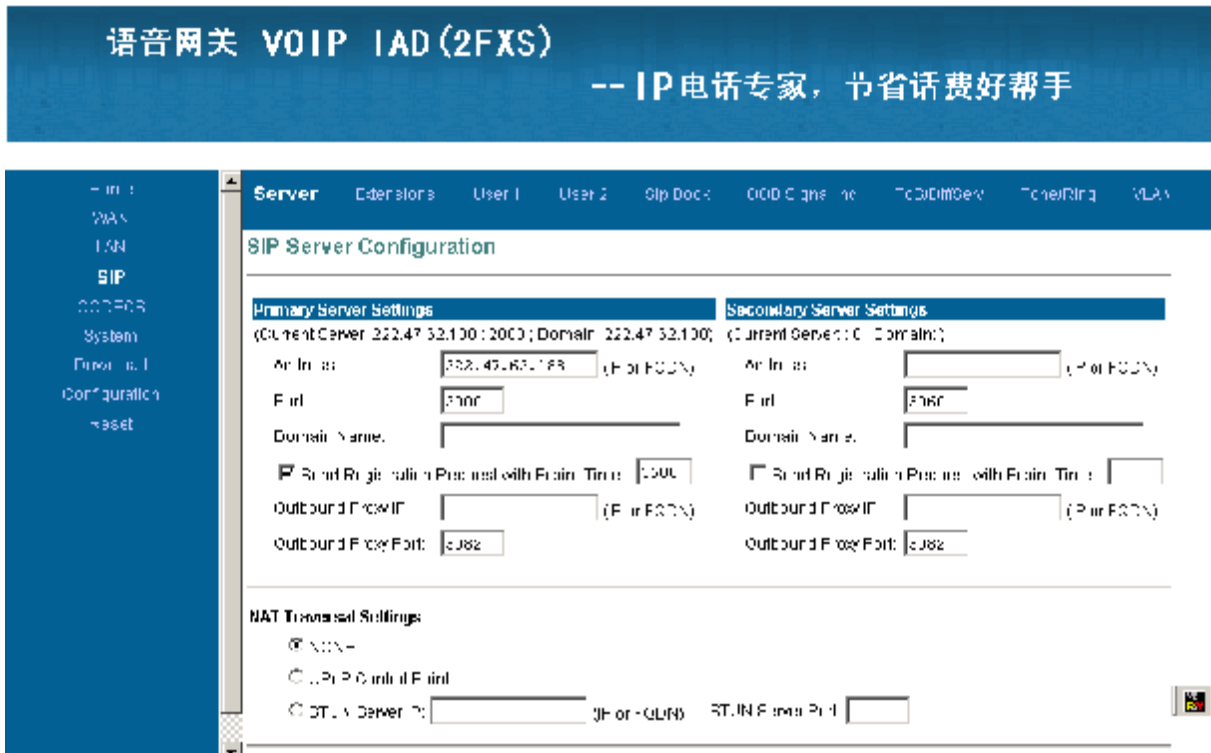

“Dial Plan” is a dialing mode. It can either be null or be configured according to your dialing mode. X represents any digit and the digit number of X represents the actual digit number. For example, there are two types of rules for numbers to be dialed: <1> beginning with “0755” and subsequently followed with an 8-digit number <2> beginning with “5” and subsequently followed with a 4-digit number. Then, configure "Dial Plan" to 0755XXXXXXXX | 5XXXX. Or, just leave it empty.

Or just a letter "T", as shown in the above figure, indicating any dialing mode



“Phone Book” is the telephone number directory in the format: Sip [XXXXXXX] @ [YYYYYYY]: [ZZZZZZ].

For the “Sip server” field, set the IP of opposite IAD first.

Deselect the “Phone book” part in the “send registration request with expire time”.

For xxxxxx, set the telephone number of opposite IAD.

For Yyyyyyy, set the IP address of opposite IAD.

For Zzzzzzzz, set the sip port of opposite IAD





9.4 H323 Protocol

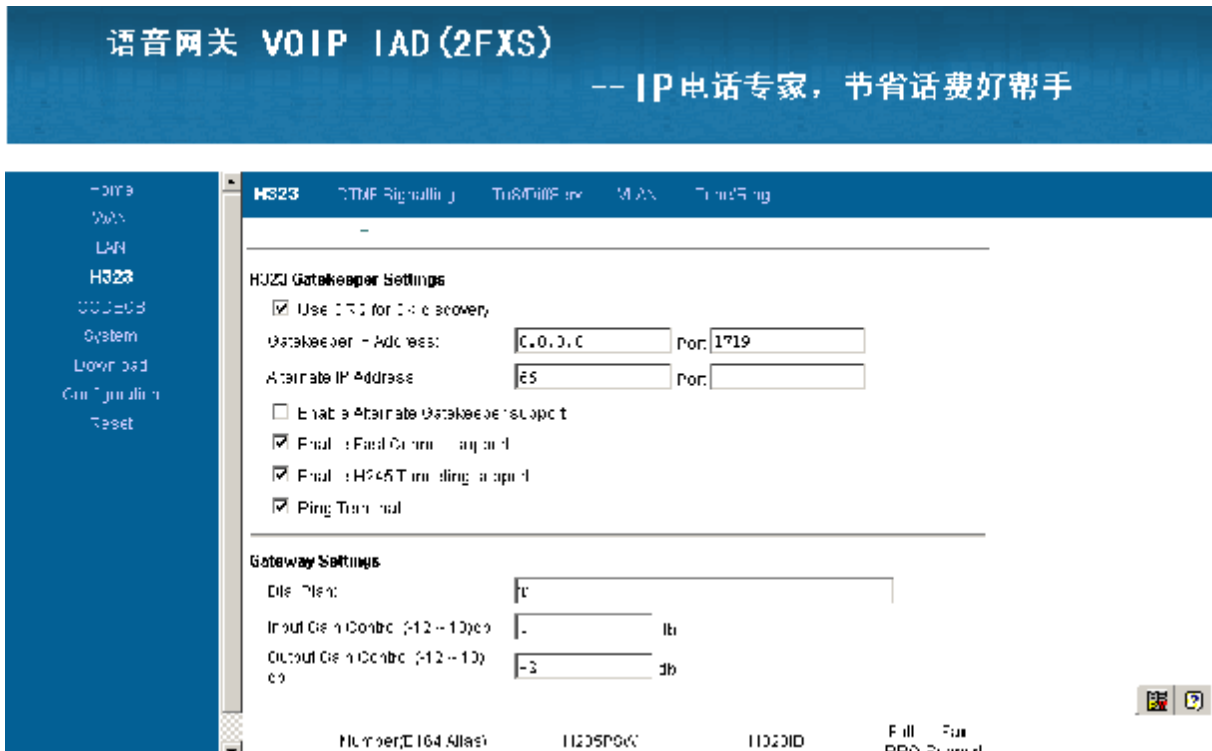

“Dial Plan” is a dialing mode. It can either be null or be configured according to your dialing mode. X represents any digit and the digit number of X represents the actual digit number. For example, there are two types of rules for numbers to be dialed: <1> beginning with “0755” and subsequently followed with an 8-digit number <2> beginning with “5” and subsequently followed with a 4-digit number. Then,

configure "Dial Plan" to 0755XXXXXXXX | 5XXXX. Or, just leave it empty.

Or just a letter "T", as shown in the above figure, indicating any dialing mode

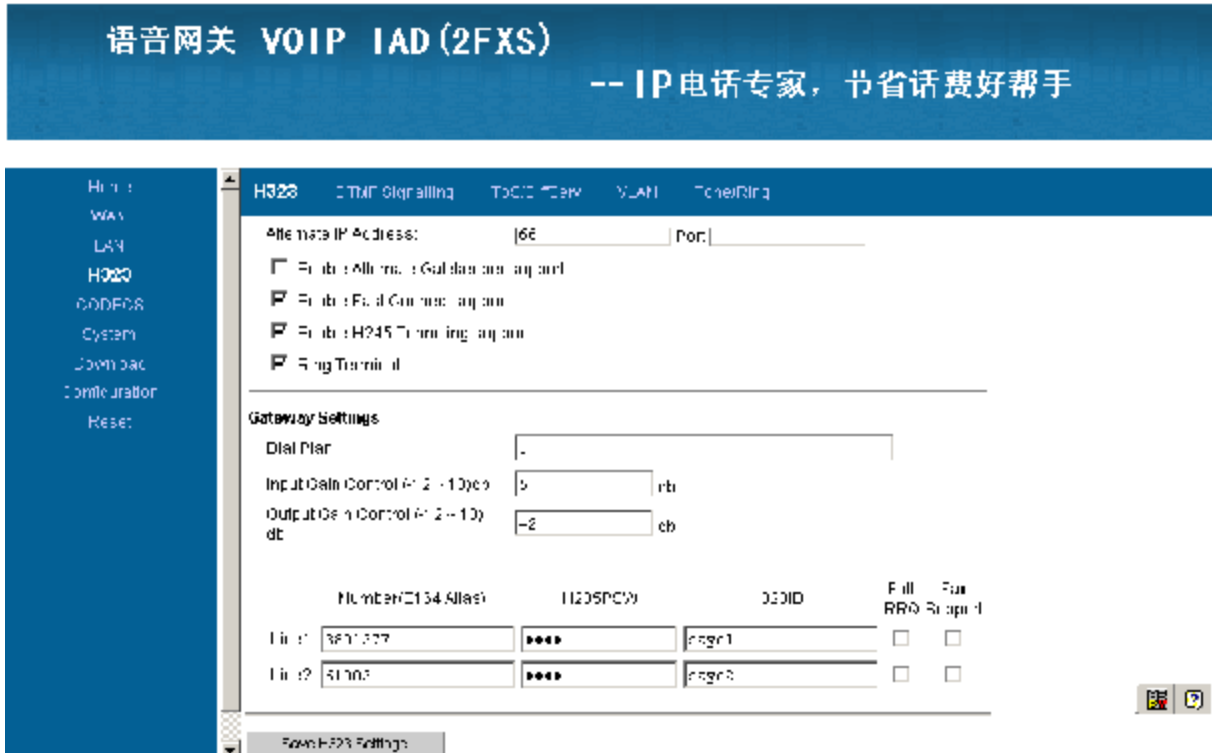

语音网关 VOIP IAD (2FXS) -- IP电话专家，节省话费好帮手

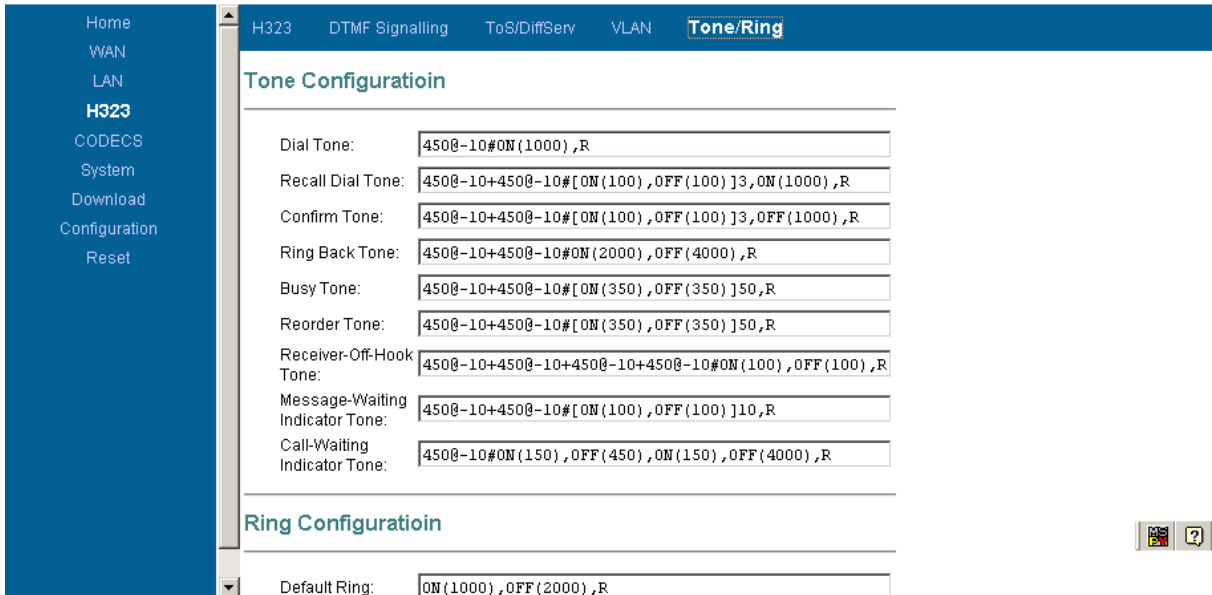

9.5 CODECS Setting

语音网关 VOIP IAD (2FXS) -- IP电话专家，节省话费好帮手

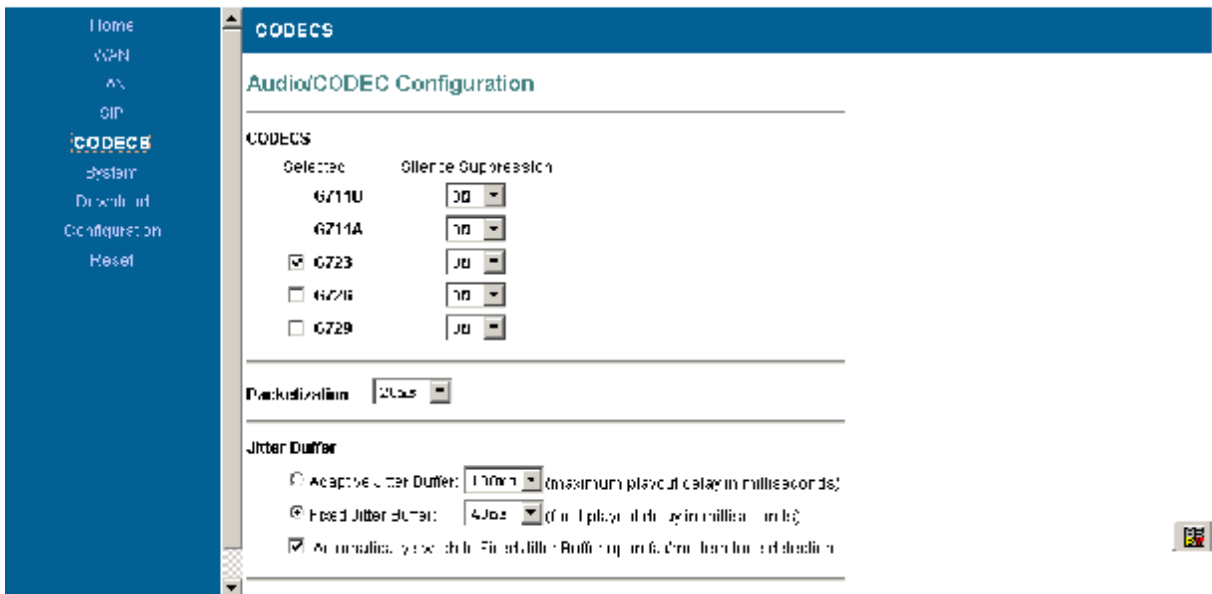

Select the voice compression code.

9.6 System Setting



Password setting



Area and time zone setting



9.7 Download Setting

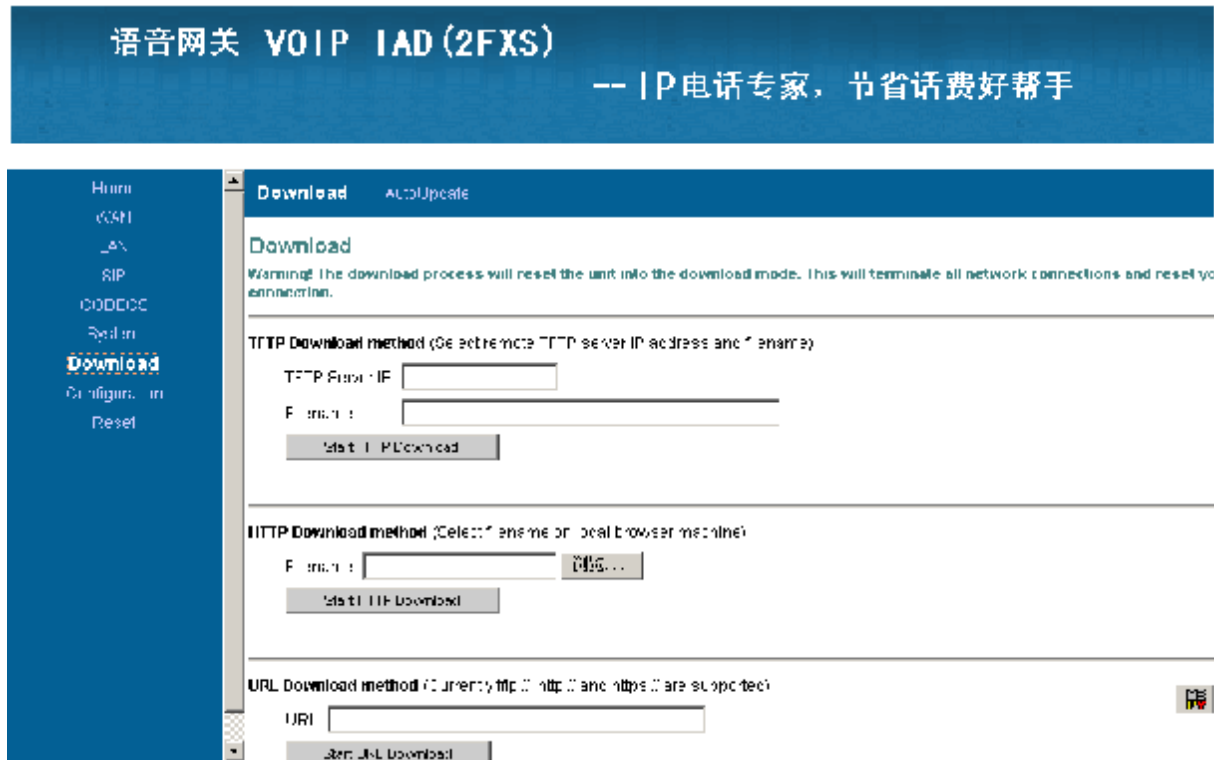

Use the TFTP mode to upgrade software and start the TFTP server on the service host. Provided the IP address of upgraded server is 192.168.1.55 and the upgrading document name is sipmh.ro, input as follows:

Then, click <Start tftp download>.

Upgrading by HTTP mode is the simplest upgrading plan, so it is recommended. Provided the upgrading document is placed in the desk\directory and the document name is sipmh.ro.

Then, click <Start tftp download>, and you will be prompted that upgrading succeeds. If unsuccessfully, repeat the above operations.

9.8 Reset Setting

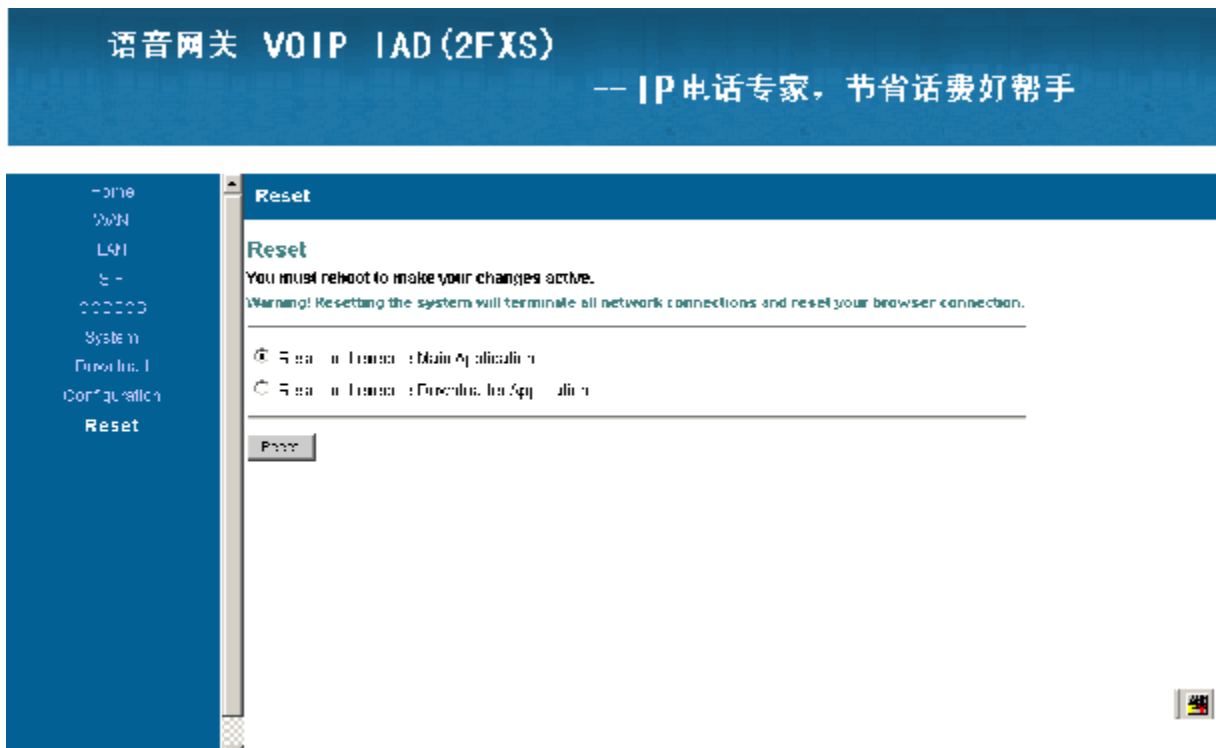

Click <Reset> to restart setting.

10 Troubleshooting

1. Confirm all cables are connected properly.
2. Check whether there is the connection through Ping action of PC
3. Connect the gateway to the LAN interface and check whether the gateway is set properly.
4. If the fault cannot be solved yet, please contact the technicians.